

42TKS (50 Hz)

Direct Expansion Fan Coil  
R- 410A Refrigerant  
Sizes 018 thru 060



## Product Data

### FAN COIL TECHNOLOGY AT ITS FINEST

The 50Hz 42TKS fan coil has the proven technology of Carrier fan coil units with Puron® refrigerant for horizontal applications. The design features contoured condensate pans with rugged drain connections, ensuring that little water is left in the unit at the end of the cooling duty cycle. The lack of standing condensate and corrosion free pans improves IAQ and product life, features homeowners appreciate.

Standard features include grooved tubing and louvered fins. Coil circuiting has also been updated to make the most of all Carrier air conditioners. Units come with solid state fan controls, 6mm thick insulation, multi- speed motors, and fully-wettable coils.



## TABLE OF CONTENTS

	<u>Page</u>
FEATURES / BENEFITS .....	2
MODEL NUMBER NOMENCLATURE .....	3
TECHNICAL DATA.....	4
UNIT DIMENSIONS .....	5
ELECTRICAL DATA .....	6
COMBINATION MATRIX .....	6
WIRING DIAGRAM .....	7
FAN PERFORMANCE.....	8
OPTIONS AND ACCESSORIES .....	9
GUIDE SPECIFICATIONS .....	9
SAFETY CONSIDERATIONS.....	11
RECEIVING / INSTALLATION / STARTUP / SERVICE .....	12-16
CONTROLLER FOR DUCTED FAN COIL UNITS .....	17-19
TROUBLESHOOTING .....	20
START-UP CHECK LIST .....	21-22

## **FEATURES / BENEFITS**

- Every compact one-piece unit arrives fully assembled, tested, and ready to run.
- Designed especially for high ambient environment.
- The drain pan is polyester powder coated for extra protection.
- Flexibility to provide left hand and right-hand coil connections.
- Metallic Blower double inlet forward curved blades.
- 3 speed motor.
- Standard galvanized sheet metal casing.
- Low unit height suitable for low false ceiling application.
- Washable aluminum filter.
- 6mm thickness internal insulation with 50 kg/m<sup>3</sup> density.
- Low noise level suitable for all application.
- Sweat connections for easy installation and maintenance.

Carrier's 42TKS direct expansion fan coils are designed to cover low to medium range of air flow requirements. They are compact and ready to fit in the under-ceiling application. All units come with solid-state fan controls, 6mm insulation, quiet multi-speed motors, and fully wet coils. 42TKS are designed for ease of service in under ceiling applications. A carton template for easy location of mounting hardware simplifies installation. Coils are made of aluminum fins mechanically bonded to copper tubes for superior heat transfer. Metallic blower double inlet forward curved blades attached to 3-speed high efficiency motors. Galvanized sheet metal casing protects against rust and drain pan is polyester powder coated for extra protection. The control board with the integrated thermostat control and washable Aluminum filters are standard feature. Piping connections position (Right Hand/Left Hand) is optional, and field interchangeable for various applications.

# MODEL NUMBER NOMENCLATURE

## MODEL: 42 TKS – R410A Series

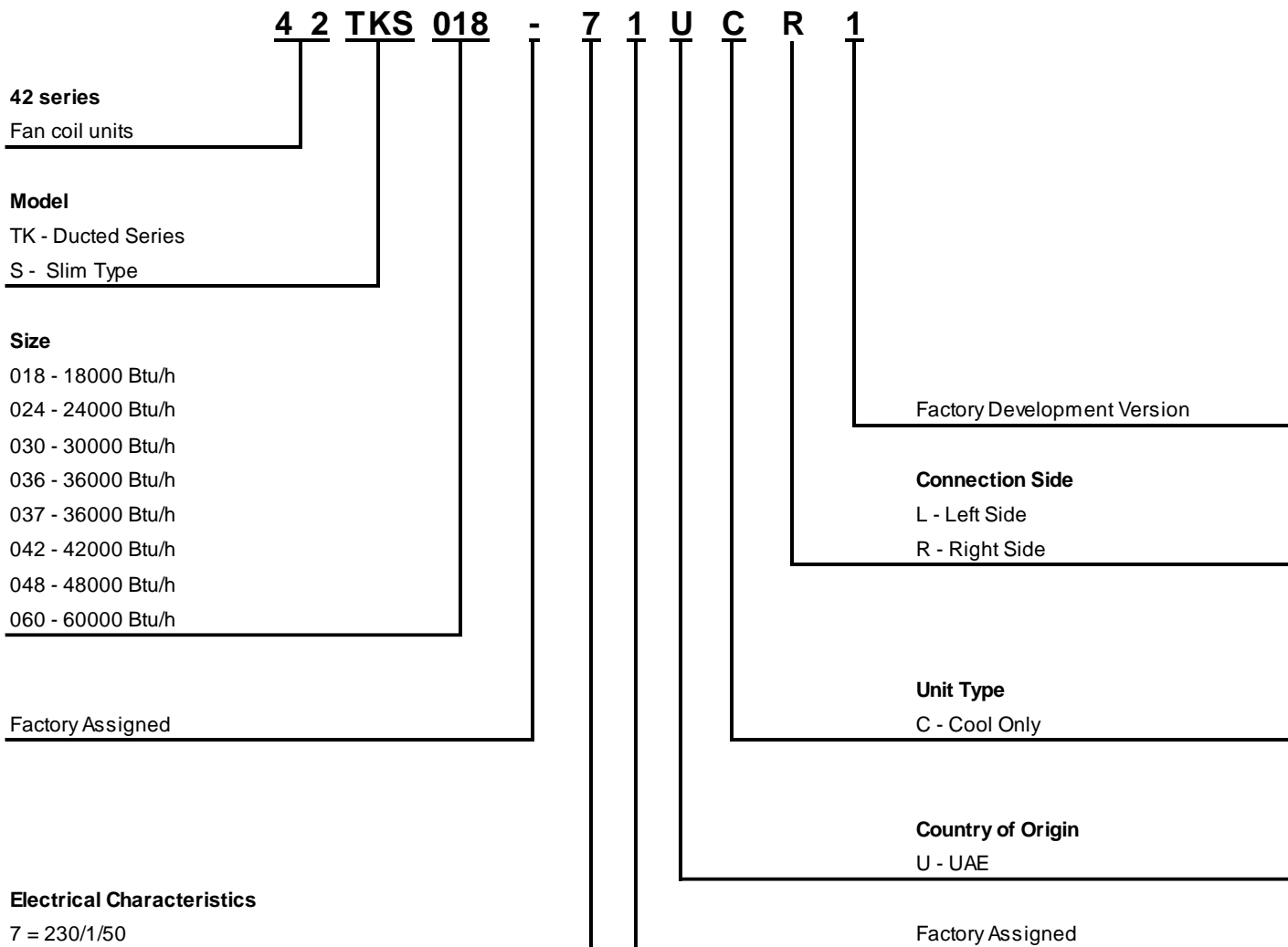

## TECHNICAL DATA

42TKS Unit Size		18	24	30	36	37	42	48	60
Unit Size	Tons	1.5	2.0	2.5	3.0	3.0	3.5	4.0	5
Motor Rated Power	Watts	80	125		200		250	300	500
Number of Motors / Speeds		1 / 3 Speed							
Coil Material	Tube	Inner grooved Copper Tubes							
	Fin	Aluminum Fins with Louvered profile							
Coil Face Area	m <sup>2</sup>	0.2	0.25	0.3	0.43	0.43	0.43	0.43	0.5
Refrigerant Metering Device		Orifice							
Piston Size		46	57	57	68	68	68	78	90
Coil Connection Type		Soldered Connection							
Suction Connection Size	Inch	5/8		3/4			7/8		
Liquid Connection Size	Inch	3/8							
Drain Connection Size	Inch	3/4 NPT / GI Steel, Externally Threaded							
Blower		Metallic Blower with Double Inlet, Forward Curved Blades							
Filter Type		1" Washable Aluminum Filter							
Filter Quantity		1	1	2	2	2	2	2	2
Filter Size	mm	675 x 215	900 x 215	550 x 215	550 x 315	550 x 315	550 x 315	550 x 315	650 x 315
Sound Pressure (H/M/L) @ ESP 0.2 in.wg at 1-meter		46/43/38	50/45/39	52/45/39	53/51/48	53/51/48	54/53/50	56/54/52	57/54/53
Unit Dimensions									
Width	mm	1040	1240	1440	1440	1440	1440	1440	1640
Depth	mm	645							
Height	mm	275				375			
Net Weight	Kg	29	33	38	55	55	57	58	68
Gross Weight	Kg	32	36	42	60	60	62	63	73

## UNIT DIMENSIONS

**Notes:**

1. The piping connections drain pan outlet and control box are located on the right-hand side facing the airflow as factory standard. Left hand connection can be provided based on request.
2. Unit shall be installed for horizontal discharge. Suspend horizontally using the factory-provided holes located at the topside flanges of the unit.

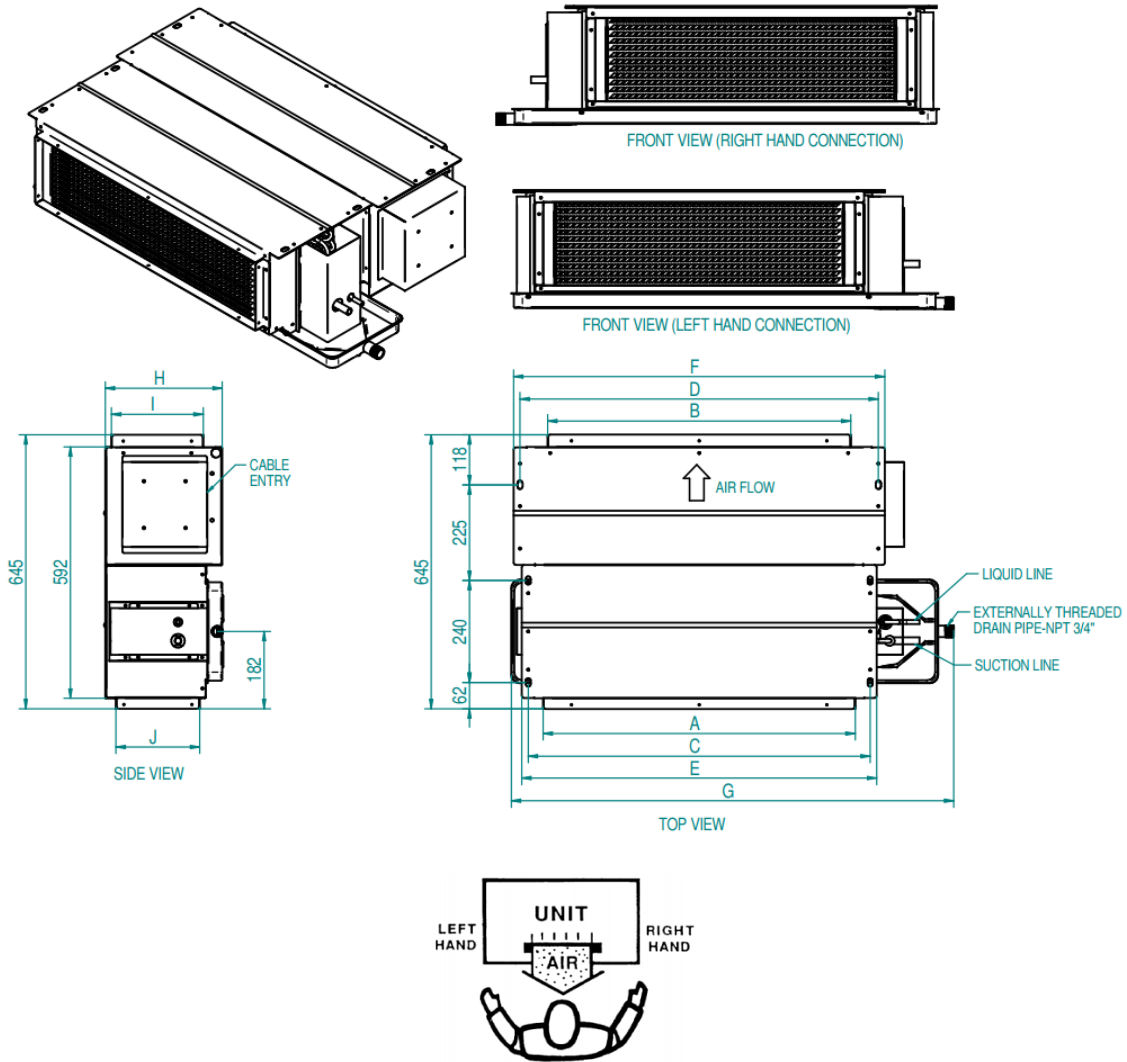

Unit Model	A	B	C	D	E	F	G	H	I	J	SUCTION LINE	LIQUID LINE
42TKS018-7	733	713	803	842	834	872	1040	275	216	197	5/8"	3/8"
42TKS024-7	958	938	1028	1067	1059	1097	1240	275	216	197	5/8"	3/8"
42TKS030-7	1158	1138	1228	1267	1259	1297	1440	275	216	197	3/4"	3/8"
42TKS036-7	1158	1138	1228	1267	1259	1297	1440	375	316	297	3/4"	3/8"
42TKS037-7	1158	1138	1228	1267	1259	1297	1440	375	316	297	3/4"	3/8"
42TKS042-7	1158	1138	1228	1267	1259	1297	1440	375	316	297	7/8"	3/8"
42TKS048-7	1158	1138	1228	1267	1259	1297	1440	375	316	297	7/8"	3/8"
42TKS060-7	1358	1338	1428	1467	1459	1497	1640	375	316	297	7/8"	3/8"

Note: Provided suction & liquid line sizes are for unit connection only; refer outdoor unit IOM for field pipe sizes.

## ELECTRICAL DATA

Unit Model	Condenser Control Circuit	Power Supply	Voltage		Fan	MCA	MOCP
			Min	Max	FLA		
42TKS018-7	24V	230V/1Ph/50Hz	207	253	1.3	1.6	15
42TKS024-7					1.3	1.6	15
42TKS030-7					1.5	1.9	15
42TKS036-7					2.5	3.1	15
42TKS037-7					2.5	3.1	15
42TKS042-7					3.0	3.8	15
42TKS048-7					3.3	4.1	15
42TKS060-7					4.0	5.0	15

### Legend

**FLA** — Full Load Amps

**MCA** — Minimum Circuit Amps

**MOCP** — Maximum Overcurrent Protection

## COMBINATION MATRIX

Outdoor Model	Indoor Model	Nominal Cooling Capacity (Btuh)	Nominal Cooling Capacity (TR)	Nominal Air Flow (CFM)
Top Discharge	Fan Coil			
38CKM018-X-7	42TKS018-7	18000	1.5	600
38CKM024-X-7	42TKS024-7	24000	2.0	815
38CKM030-X-7	42TKS030-7	30000	2.5	890
38CKM036-X-7	42TKS036-7	36000	3.0	1165
38CKM036-X-9	42TKS037-7	36000	3.0	1165
38CKM042-X-9	42TKS042-7	42000	3.5	1350
38CKM048-X-9	42TKS048-7	48000	4.0	1425
38CKM060-X-9	42TKS060-7	60000	5.0	1765

*For detailed performance and matchup ratings please refer to corresponding outdoor product catalog.*

# WIRING DIAGRAM

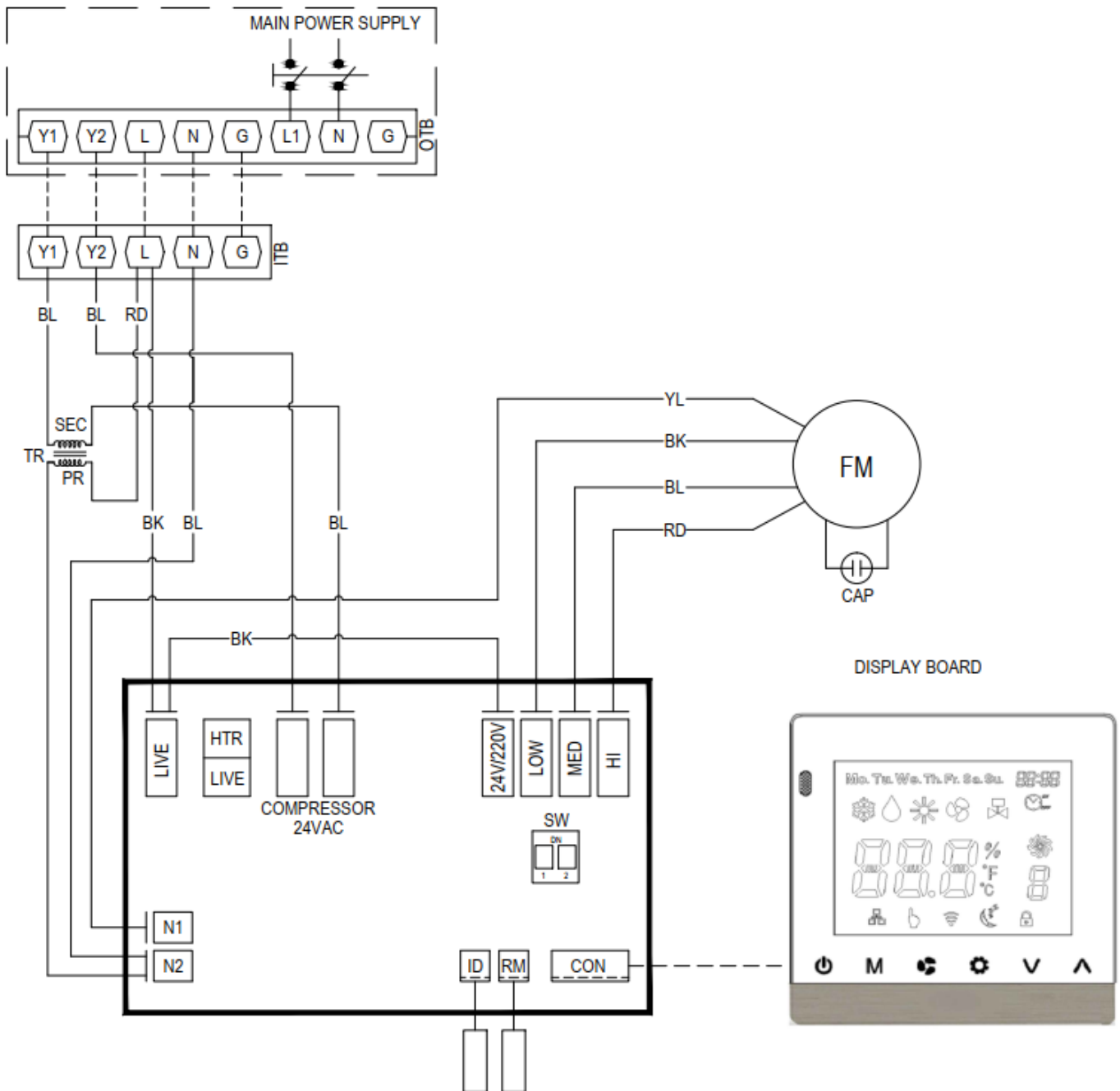

## LEGEND

FM : FAN MOTOR  
 CAP : CAPACITOR  
 SW : DIP SWITCH  
 RM : ROOM SENSOR  
 ID : INDOOR COIL SENSOR  
 ITB : INDOOR UNIT TERMINAL BLOCK  
 OTB : OUTDOOR UNIT TERMINAL BLOCK  
 TR : TRANSFORMERS  
 WIRE COLORS  
 BR : BROWN    RD : RED  
 BL : BLUE     WH : WHITE  
 OR : ORANGE   BK : BLACK  
 YL : YELLOW

## TERMINAL BLOCK LEGEND

Y1 & Y2 : OUTDOOR UNIT CONTROL - 24VAC  
 G : GROUND CONNECTION  
 L : LIVE CONNECTION  
 N : NEUTRAL CONNECTION  
 NOTE  
 ----- FILED WIRING

## DIP SWITCH SETTING

DIP SWITCH	ON	OFF
SW1	COOL	OFF
SW2	-	DX SYSTEM

## FAN PERFORMANCE

### 42TKS Air Flow (CFM) – English

ESP - in.wg	0.1			0.2			0.3			0.4		
Unit Model	H	M	L	H	M	L	H	M	L	H	M	L
42TKS018-7	673	600	438	621	543	392	536	473	320	438	360	242
42TKS024-7	990	815	477	936	747	432	853	679	365	761	585	261
42TKS030-7	1039	929	706	990	890	674	927	833	646	853	767	582
42TKS036-7	1316	1180	842	1296	1165	753	1262	1132	702	1200	1076	644
42TKS037-7	1316	1180	842	1296	1165	753	1262	1132	702	1200	1076	644
42TKS042-7	1436	1370	977	1415	1350	876	1382	1316	816	1303	1237	740
42TKS048-7	1629	1474	1286	1534	1425	1203	1492	1386	1160	1420	1326	1116
42TKS060-7	1940	1854	1618	1853	1765	1488	1804	1712	1434	1711	1613	1357

### 42TKS Air Flow (L/S) – SI

ESP - Pa	25			50			75			100		
Unit Model	H	M	L	H	M	L	H	M	L	H	M	L
42TKS018-7	318	283	207	293	256	185	253	223	151	207	170	114
42TKS024-7	467	385	225	442	353	204	403	320	172	359	276	123
42TKS030-7	490	438	333	467	420	318	437	393	305	403	362	275
42TKS036-7	621	557	397	612	550	355	596	534	331	566	508	304
42TKS037-7	621	557	397	612	550	355	596	534	331	566	508	304
42TKS042-7	678	647	461	668	637	413	652	621	385	615	584	349
42TKS048-7	769	696	607	724	673	568	704	654	547	670	626	527
42TKS060-7	916	875	764	875	833	702	851	808	677	808	761	640

**Legend:**

**CFM** — Cubic feet per minute

**L/S** — Liter per second

**in.wg** — Inches of water gauge

**Pa** — Pascals

**ESP** — External static pressure

**H** — High speed, **M** — Medium speed, **L** — Low speed,



## **OPTIONS AND ACCESSORIES**

### **Connection Side Option**

Standard coil connection and electric box position is Right Hand facing air flow direction while the optional position is Left Hand facing the air flow for both coil connection and electric box. Customers can order this option directly from the factory. Also, units are designed to be field exchangeable if needed in the field.

### **Control Board Wire Extension**

Standard wire length for control board is 15m. Optional extensions are available to enlarge the wire up to 30 m. If extension is required, please contact your local Carrier dealer.

## **GUIDE SPECIFICATIONS**

### **COOLING ONLY DX INDOOR UNIT**

**SIZE: 1.5 TR TO 5.0 TR**

### **SYSTEM DESCRIPTION**

The direct expansion indoor units are designed for under ceiling installation, electrically controlled cooling. Unit shall be horizontal installation.

### **QUALITY ASSURANCE**

- a) Units are designed / manufactured in accordance with ISO 9001:2015 facilities, International Standard for Quality Systems.
- b) Units are designed to conform to ASHRAE safety standard.
- c) Units are rated in accordance with ISO 13253 testing standard at T1 and T3 conditions.
- d) Insulation and adhesives are conforming to NFPA 90A requirements for flame spread and smoke generation.
- e) Units are run tested before packing.

### **DELIVERY STORAGE AND HANDLING**

- a) Unit shall be stored and handled per manufacturer's recommendations.
- b) Lifting by crane requires either shipping top panel or spreader bars.
- c) Unit shall be stored or positioned in the upright position.

### **PRODUCT**

- a) The units are factory assembled single piece cooling units.
- b) Unit cabinet shall be constructed of galvanized steel.
- c) Standard ducted unit's inner sections are insulated with NBR Elastomeric closed cell foam insulation, 50kg/m<sup>3</sup> density.
- d) Drain pan is polyester powder coated on both sides & insulated outside.
- e) The unit fan wheel shall be directly connected to the motor. The fan wheel shall be dynamically balanced with double inlet forward curved type blower wheel.
- f) All coils are with 9.52mm seamless copper tubes and aluminum fins. Coil fins are mechanically bonded to copper pipes.
- g) The coil connections are sweat type LH/RH exchangeable.
- h) The unit fan motors are with permanently lubricated sleeve bearing and 3 speeds. The motor shall have internal overload protection and B class insulation.
- i) Unit shall have a wired control board with a built-in thermostat to be installed in the air-conditioned area and it shall have the following Features:
  - i. Control Modes – Cool, Dry, Fan, Auto Cool and Sleep mode.
  - ii. Compressor protections – 3 minutes restart protection.
  - iii. Indoor coil anti-freeze protection.
  - iv. Failure monitoring for room sensor and indoor coil sensor.
  - v. Non-volatile memory – keep system settings.
  - vi. Programmable On/Off timer.
  - vii. Random Restart Time Delay – to minimize voltage dip during compressor first cut in cycle upon power up for multiple units' operation.
- j) All electric parts are easily accessible for service.

## **INSTALLATION & OPERATIONS INSTRUCTIONS**

## SAFETY CONSIDERATIONS

The appliance is not to be used by persons (including children) with reduced physical, sensory or mental capabilities, or lack of experience and knowledge, unless they have been given supervision or instruction. Children should be supervised not to play with the appliance.

Improper installation, adjustment, alteration, service, maintenance or use can cause explosion, fire, electrical shock or other conditions which may cause personal injury or property damage. Consult a qualified installer; service agency must use factory-authorized kits or accessories when modifying this product. Refer to the individual instructions packaged with the kits or accessories when installing. Follow all the safety codes. Wear safety glasses and work gloves. Use quenching cloths for brazing operations and have a fire extinguisher available. Read these instructions thoroughly and follow all warnings or cautions attached to the unit. Consult local building codes for special requirements. In absence of local codes, it is recommended that the USA standard ANSI/NFPA 70, National Electrical Code (NEC), be followed.

It is important to recognize safety information. This is the safety-alert symbol . When you see this symbol on the unit and in instructions or manuals, are alert to the potential for personal injury. Understand the signal words **DANGER, WARNING, CAUTION, and NOTE**. These words are used with the safety-alert symbol. DANGER identifies the most serious hazards which will result in severe personal injury or death. WARNING signifies hazards which could result in personal injury or death. CAUTION is used to identify unsafe practices, which may result in minor personal injury or product and property damage. NOTE is used to highlight suggestions which will result in enhanced installation, reliability, or operation.

## INSTALLATION SAFETY CONSIDERATIONS

After the unit has been received and when it is ready to be installed or reinstalled, it must be inspected for damage. If damage is detected upon receipt, immediately file a claim with the shipping company or repair. This machine must be installed in a location that is not accessible to the public and protected against access by non-authorized people. This machine must not be installed in an explosive atmosphere.

Do not remove the skid or the packaging until the unit is in its final position. The units can also be lifted with slings, using only the designated lifting points marked on the unit (labels on the chassis and a label with all unit handling instructions are attached to the unit). Use slings with the correct capacity, and always follow the lifting instructions on the certified drawings supplied for the unit.

Motors are permanently lubricated; use of any external lubricant (including WD40) is not allowed. For units without factory supplied control it is the full responsibility of the user to install proper controls matching the unit's design and capable to carry components current, control wiring should be strictly follow local/national electrical codes (i.e. using telephone wires or similar is prohibited). Safety is only guaranteed, if these instructions are carefully followed. If this is not the case, there is a risk of material deterioration and injuries to personnel.

### **WARRANTY**

Warranty is based on the general terms and conditions of the manufacturer. Any modifications to the design and/or installation made without discussion with Carrier and without advance written agreement will result in the loss of the right to any warranty claims and any claim for injury to personnel as a result of these modifications.



**WARNING - THE MANUFACTURER'S WARRANTY DOES NOT COVER ANY DAMAGE OR DEFECT TO THE AIR CONDITIONER CAUSED BY THE ATTACHMENT OR USE OF ANY COMPONENTS, ACCESSORIES, OR DEVICES (OTHER THAN THOSE AUTHORIZED BY THE MANUFACTURER) INTO, ONTO, OR IN CONJUNCTION WITH THE AIR CONDITIONER. YOU SHOULD BE AWARE THAT THE USE OF UNAUTHORIZED COMPONENTS, ACCESSORIES, OR DEVICES MAY ADVERSELY AFFECT THE OPERATION OF THE AIR CONDITIONER AND MAY ALSO ENDANGER LIFE AND PROPERTY. THE MANUFACTURER DISCLAIMS ANY RESPONSIBILITY FOR SUCH LOSS OR INJURY RESULTING FROM THE USE OF SUCH UNAUTHORIZED COMPONENTS, ACCESSORIES, OR DEVICES.**

## RECEIVING

42TKS fan coil units are shipped individually packed in carton boxes. When cartons are individually off loaded from the truck, do not roll, or throw, or drop the carton to avoid damage to the contents. Store boxes upright as the symbols on the boxes indicated. Do not stack units more than 8 units high for sizes 018-024 and 6 units high for sizes 030 - 060.

### UNPACKING INSTRUCTIONS

1. Prepare unit for unpacking
2. Remove two (2) pieces, of plastic straps
3. Open carton flaps
4. Lift unit assembly carefully out of carton box

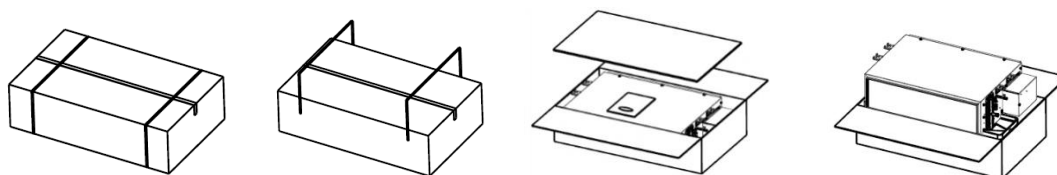

Unpacking Instructions

### PACKING INSTRUCTIONS

1. Lift unit assembly and carefully place into the carton box.
2. Place the IOM
3. Close carton flaps and seal with tape along flap side, wrap with two (2) pieces of plastic straps around the box

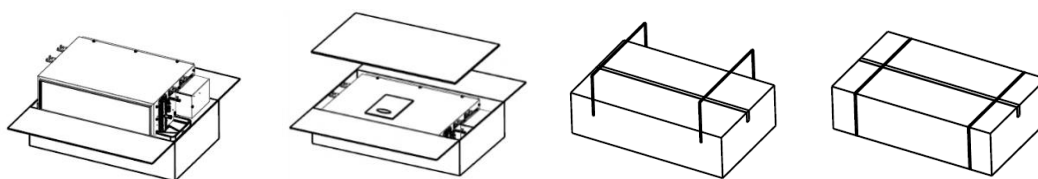

Packing Instructions

### INSPECTION

Check the shipment against shipping list, remove unit from the carton and take off protective covering. If the unit has been damaged, file claim with transportation company and notify Carrier immediately.

### PROTECTION

Protect unit from damage caused by job site debris. Do not allow dust, debris and water to get into the unit. This will damage unit's component and unit's performance will be affected.

### PRELIMINARY CHECK

Following is a checklist which should be checked before the installation is started. The installer should be familiar with each of the following requirements before the actual installation.

1. Space requirements and clearances.
2. Ceiling or mounting strength.
3. Piping connections.
4. Condensate drains connection.
5. Power supply and wiring.
6. Air duct connections.
7. The condensing unit model number is the recommended by the factory (as per "Combination Ratings and Matrix").

## **PREPARE JOBSITE FOR UNIT INSTALLATION**

To save time and to reduce the possibility of costly errors, set up a complete sample installation in a typical room at jobsite. Check all critical dimensions such as pipe, wire, and duct connection requirements. Refer to job drawings and product dimension drawings as required. Instruct all trades in their part of the installation.

## **IDENTIFY AND PREPARE UNITS**

Be sure power requirements match available power source. Refer to unit nameplate and wiring diagram.

1. Check all tags on unit to determine if shipping screws are to be removed. Remove screws as directed.
2. Rotate the fan wheel by hand to ensure that the fan is unrestricted and can rotate freely. Check for shipping damage and fan obstructions.

## **UNIT CONFIGURATION**

The piping connections drain pan outlet and control box are located on the right side of the unit facing the airflow direction as factory standard as shown in the unit picture. Left hand side connection is a factory option. However, the connections side can be relocated at site.

## **RIGGING AND UNPACKING**

Unit should not be removed from carton until reaching final location to avoid damage. Inspect unit for shipping damage and file claim with transportation company if necessary, check nameplate voltage against available power supply. For special installation, consult local building and electrical codes.

# **INSTALLATION**

---

## **PLACING UNIT IN POSITION**

1. Select the unit location. Allow adequate space for free air circulation, service clearances, piping and electrical connections, and any necessary ductwork.
2. Be sure that the ceiling can support the weight of the unit. See "Physical Data" for nominal unit weight.
3. Move unit into position. Ensure unit is level or pitched towards drain to ensure proper drainage and operation.
4. Mounting units to the ceiling - When unit is lifted, access to the mounting holes is on the top panel of the unit. Hanger rods, fasteners, and other required hardware must be field supplied.

## **PIPING CONNECTIONS**

Qualified personnel in accordance with local and national codes must perform all piping connections. Refer to "Physical Data" for piping connections. NOTE: It is important to have a common understanding of which side of the unit is the right-hand side and which is the left-hand side. When facing the supply air outlet from the front of the unit (air blowing in your face), your right hand will be on the right side of the unit and your left hand will be on the left side of the unit. Use the condensing unit manufacturer's recommended line sizes and requirements; see "Combination Ratings and Matrix". **Suction line must be insulated for correct operation.** Use refrigerant-grade copper lines only. The unit is not applied as a heat pump.

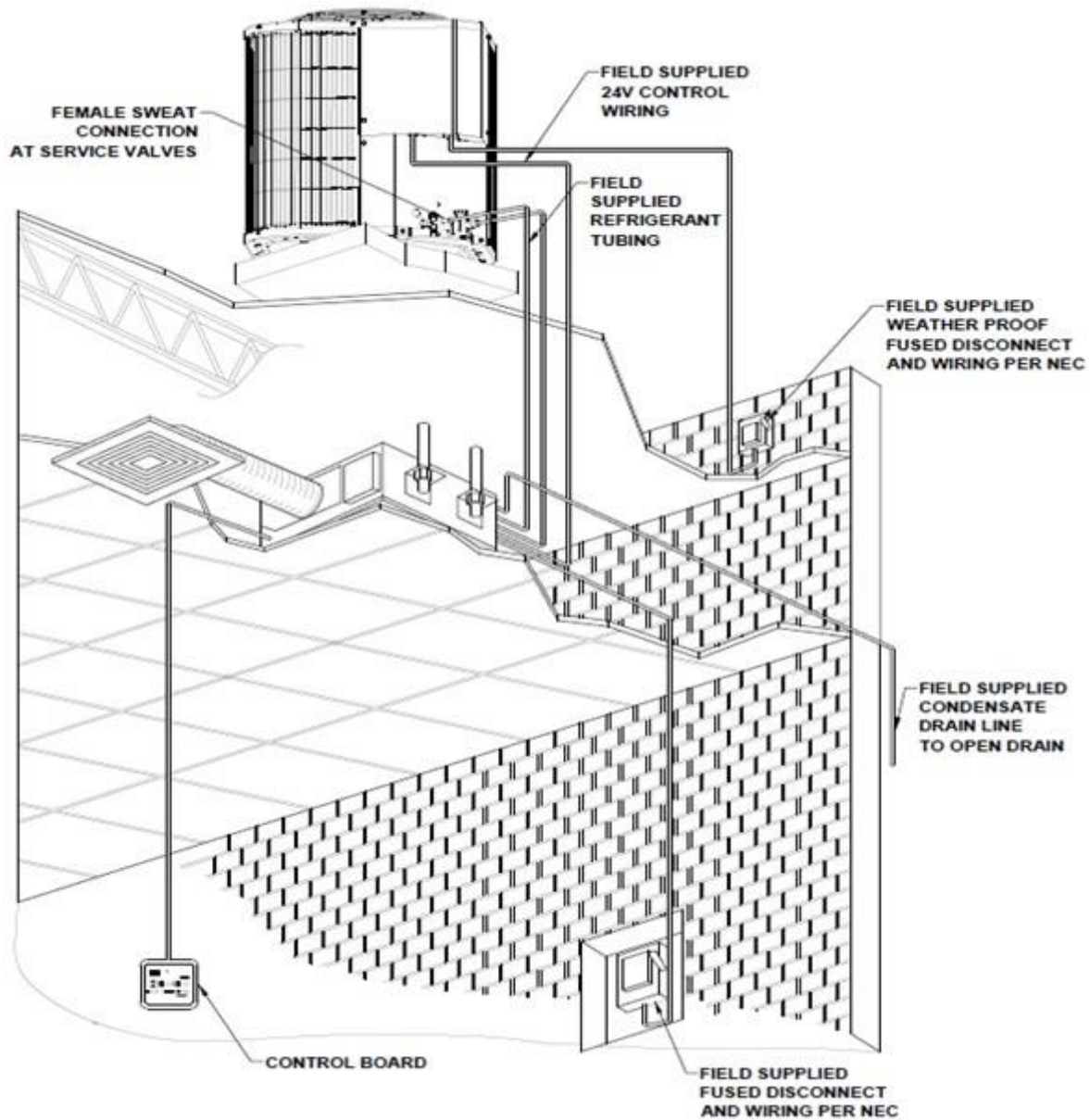

Typical Wiring & Piping Connections

**NOTES:**

1. All piping must follow standard refrigerant piping techniques.
2. All wiring must comply with the applicable local and national electric codes.
3. Wiring and piping shown are general points-of-connection guides only not intended for a special installation.
4. Insulate condensate line if run above a conditioned space.
5. The control board kit is factory supplied; no thermostat required.
6. The wall mounted wired room controller could control all system functions without wireless remote control.
7. Standard wire length for the control board is 7.5 m. If extension is required, please consult Carrier.

## TEST AND INSULATE

When all joints are complete, perform hydrostatic test for leaks. Vent all coils at this time. Check interior unit piping for signs of leakage from shipping damage or mishandling. If leaks are found, notify a Carrier representative before initiating any repairs. Release trapped air from system (refer to Final Preparations section).

## ELECTRICAL CONNECTIONS

Refer to unit nameplate for required supply voltage, fan amperage and required circuit amp. Refer to unit wire diagram for unit and field wiring; see "Typical Wiring & Piping Connections", "Typical Wiring Schematic" and "Electrical Data". Make sure all electrical connections are in accordance with unit wiring diagram and all applicable codes. The fan motor(s) should never be controlled by any wiring or device other than the factory-supplied control board. All field wiring must be in accordance with governing codes and ordinances. Any modification of unit wiring without factory authorization will invalidate all factory warranties and nullify any agency listings.

- Select proper wall location to fix display pad
- Connect communication cable end to its location in the PCB as shown in the wiring diagram.

Follow local/national wiring regulations and code for all wiring to the unit, in absence of local codes use power supply wires sizes which are at least 1.25 times the unit's full load current and circuit breaker size 2 - 2.25 times the unit's full load current.

## DUCT CONNECTIONS

Install all ductwork to and from unit in accordance with all applicable codes. Duct construction must allow unit to operate within duct external static pressure limits as shown on job submittals. Units designed to operate with ductwork may be damaged if operated without intended ductwork attached. Units provided with outside air should have some method of low-temperature protection to prevent freeze-up. Insulate ductwork as required. Use flexible connections to minimize duct-to-unit alignment problems and noise transmission where specified. Set unit markings for minimum clearance to combustible materials and first 3 ft of ductwork. Install ductwork, accessory grilles and plenums so that they do not restrict access to filter. Cut openings for supply-air and return-air grilles. Be careful not to cut wires, piping or structural supports.

**Caution:** Prevent dust and debris from settling in unit. If wall finish or color is to be spray applied, cover all openings to prevent spray from entering unit. Unit efficiency will be reduced.

## FINAL PREPARATIONS

1. Turn off power to the unit (open unit electrical disconnect).
2. Install the wired control panel kit and perform any other final wiring as applicable, see the controller for ducted fan coil units' section.
3. Clean dirt, dust, and other construction debris from unit interior. Be sure to check fan wheel and housing.
4. Rotate fan wheel by hand to be sure it is free and does not rub housing. Check that wing nuts securing fan assembly to fan deck are tight.
5. Be sure drain line is properly and securely positioned and that the line is clear. Pour water into drain to check operation.

**Important:** Do not start-up or operate unit without filter. Be sure filter and unit interior are clean.

## START-UP

42TKS unit is designed to operate in hot and humid conditions without condensation problem because of the rubber insulated drain pan. Refer to the "Mandatory Startup Checklist and Record" for startup procedure.

## **SERVICE**

**Warning:** Failure to follow this caution may result in equipment damage. Motors are permanently lubricated; Please do not use any external lubricant.

### **CLEAN COIL**

1. Be sure electrical service switch is open, locked, and tagged while working on unit.
2. Coil can be cleaned by removing filter and bottom panel and brush between coil fins with stiff wire brush. Follow-up by cleaning with vacuum cleaner. If coil is cleaned with air hose and nozzle, take care not to drive dirt and dust into other components.

### **CHECK DRAIN**

Lock open and tag unit electrical service switch. Check drain pan drain line and trap at start of each cooling season. A standard type pipe cleaner for 3/4-in. ID pipe can be used to ensure that pipe is clear of obstruction so that condensate is carried away.

### **CLEAN FAN WHEEL**

Lock open and tag unit electrical service switch. For access to fan assembly, remove supply air duct and bottom panel. Use a stiff brush or vacuum to remove dirt and debris from scroll. Wipe all fan surfaces with a damp cloth.

### **CLEAN OR REPLACE AIR FILTERS**

Lock open and tag unit electrical service switch. At the start of each cooling season and after each month of operation (depending on operating conditions) replace throwaway filter or clean permanent filter.

### **THROWAWAY FILTER**

Replace filter with a good quality filter of the size shown in "Physical Data". Do not attempt to clean and reuse disposable filters.

### **PERMANENT FILTER**

1. Tap on solid surface to dislodge heavy particles.
2. Wash in hot water.
3. Set filter on end so that water drains out through slots in frame. Allow filter to dry thoroughly. See Fig.8 for filter access.



# UNIT CONTROLLER

## 1.1 Functions:

- Modes: Cool, Dry and Fan.
- Fan Speed: High, Medium, Low.
- Sleep Mode, programmable On/Off timer.
- Compressor protections: Compressor 3-minute restart protection, Indoor coil anti-freeze, Room Sensor and indoor coil sensor failure monitoring.
- Random restart to minimize voltage dip during compressor first cut in cycle upon power up.

## 1.2 Hardware Setting: A 2-way DIP switch is used to configure:

DIP Switch	ON	OFF
SW1	Cool	OFF
SW2	-	DX system

## 1.3 Error Code: The corresponding error code will be shown one after another, in-case if multiple faults.





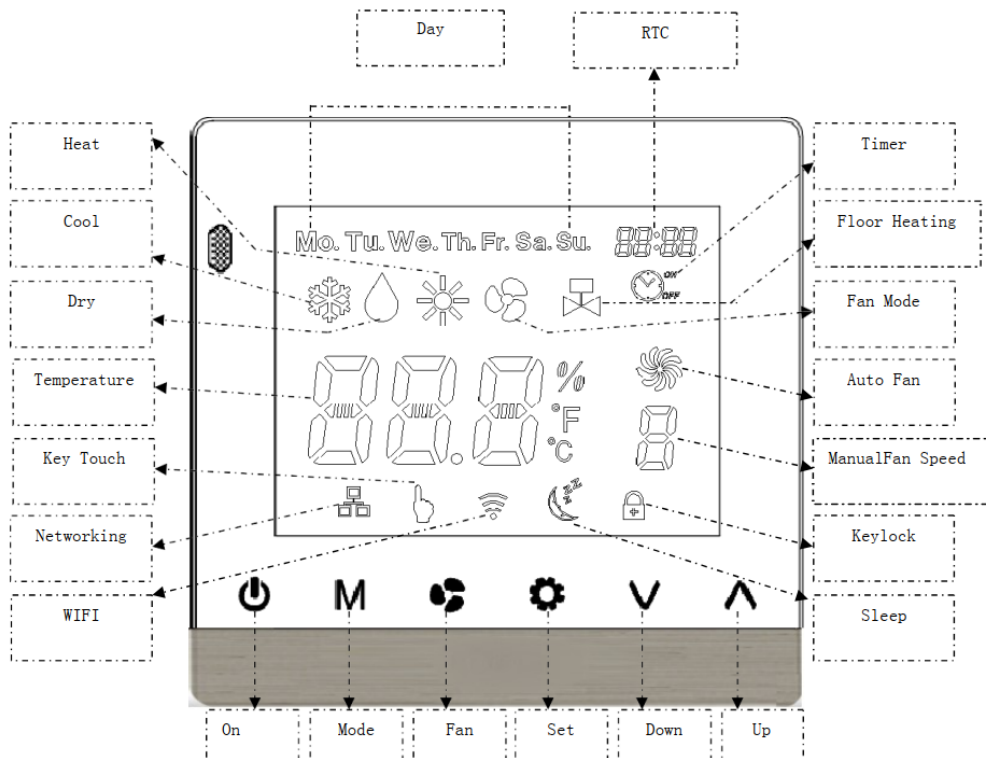

Error code	E1	E2	E4
Fault	Room Sensor	Indoor coil sensor	Compressor





























## 1.4 Description:

### 1) LCD Screen



2) Key Function:

Icon						
Function	On / Off	Mode	Fan	Set	Down	Up



- 3) **System On/Off:** Press  to turn on or off the unit.
- 4) **Mode:** Press  key to change operating mode as follow:  
Cool Only Model: Cool – Dry – Fan
- 5) **Fan Speed:** Press  key to select: Auto – High – Medium – Low which is indicated as A-3-2-1 on fan speed digital setting. Fan key is invalid in Dry mode.
- 6) **Temperature Setting:** Press  or  key to adjust set temperature. Temperature setting is 20°C to 30°C or 68°F to 85°F. Temp keys are invalid in Fan mode. Press  and  key together to switch between Celsius to Fahrenheit setting.
- 7) **Sleep:** Hold on  key to toggle sleep mode setting. Sleep key is invalid in Fan or Dry mode. Sleep mode will automatically cancel after 8 hours.
- 8) **RTC:** Press  key to enter RTC setting. Press  or  key to adjust hour or minute. Press  key to select hour, minute or day of week. Press  key to confirm and exit.
- 9) **Timer On or Off:** Press  and  keys to enter timer setting. Press  key to change items as follow: day of week, timer on enable or disable, timer on hour, timer on minute, timer off enable or disable, timer off hour, timer off minute. (When hour or minute being selected, it will flash).  
Press  or  key to adjust the time for timer on or off being selected. Press  key to confirm and exit. Press  key to exit and ignore setting. It will exit and ignore setting automatically 6 sec after last key press. If timer ON is programmed ON symbol lights on. If timer off is programmed OFF symbol lights on. If ON or OFF timer is available for current day of week, Timer symbol lights on.
- 10) **Cancel Timer:** Hold  key for 3 seconds to cancel all timer settings.
- 11) **Key Lock:** In main menu, hold on  and  key to lock or unlock the keys. In key lock mode only  key is invalid.
- 12) **Information Browsing:** Press   keys for 3 sec to browse the following temperature.  
Press  or  key to browse the temperature. Press  key to exit.

RTC Display Zone	Temperature Display Zone
A1	Room Temperature
A2	Indoor Coil Temperature

**13) Error Code Display:** Should there be any system error, it will be shown on temperature display zone. If multiple faults happen at the same time, the corresponding error code will be shown one after another.

Fault	Error Code
Room sensor fault	E1
Indoor coil sensor fault	E2
Compressor fault	E4
Communication fault	E15

**14) Edit System Parameter:** Press  and  key enter password menu. Key in password “1111” by  or  key to change selected digit.

Press  key to select the password digit. Press  key to verify the password. If password entry is correct, RTC display area will show the submenu number.

Press  or  key to select the sub menu, press  or  key to adjust the value selected sub menu.

Press  key to confirm and exit. Press  key to exit and ignore setting.

Submenu	Description	Range	Options
A1	Temp display	1 ~ 2	1: Disable Room Temp Display 2: Enable Room Temp Display
A2	Cool mode fan control function	1 ~ 2	1: Compressor off; Fan On 2: Compressor off; Fan off

## TROUBLESHOOTING

Symptom	Possible Causes	Remedy
Unit will not run	Power off or loose electrical connection	Check for correct voltage at contactor in condensing unit.
	Thermostat out of calibration-set too high	Reset.
	Defective contactor	Check for control voltage at contactor coil - replace if contacts are open.
	Blown fuses or Transformer defective	Replace fuses / Check wiring-replace transformer.
	High pressure control open (if provided)	Reset-also see high head pressure remedy-The high-pressure control opens at 650PSIG
Outdoor fan runs, compressor doesn't	Run or start capacitor defective	Replace
	Start relay defective	Replace
	Loose connection	Check for correct voltage at compressor check & tighten all connections
	Compressor stuck, grounded or opens motor winding.	Wait at least 2 hours for overload to reset. Open internal overload. If still open, replace the compressor.
	Low voltage condition	Add start kit components
Insufficient cooling	Improperly sized unit	Recalculate load
	Improper indoor airflow	Check, remove obstructions - clean filters if necessary
	Incorrect refrigerant charge	Charge per procedure attached to unit service panel
	Air, non-condensable or moisture in system	Recover refrigerant, evacuate & recharge, add filler drier.
Compressor short cycles	Incorrect voltage	At compressor terminals, voltage must be $\pm 10\%$ of nameplate marking when unit is operating.
	Defective overload protector	Replace, if external - check for correct voltage
	Refrigerant undercharge	Add refrigerant
Indoor unit sweats	Low indoor airflow	Increase speed of blower or reduce restriction -clean air filters.
	Improper indoor unit installation	Assure condensate is draining properly & that insulation is dry.
High head-Low vapor pressures	Restriction in liquid line, expansion device or filter drier	Remove or replace defective component.
High head-high or normal vapor pressure - Cooling mode	Dirty outdoor coil	Clean coil
	Refrigerant overcharge	Correct system charge
	Outdoor fan not running	Repair or replace.
	Air or non-condensable in system	Recover refrigerant, evacuate & recharge
High head - high or normal vapor pressure - Heating mode	Low air flow - indoor coil	Check filters - correct to speed
	Refrigerant overcharge	Check system charge
	Air or non-condensable in system	Recover refrigerant, evacuate & charge
	Dirty indoor coil	Check filter - clean coil
Low head-high vapor pressures	Defective Compressor valves	Replace compressor
Low vapor - cool compressor - iced indoor coil	Low indoor airflow	Increase speed. of blower or reduce restriction
	Moisture in system	clean air filter iced indoor coil
High vapor pressure	Excessive load	Recheck load calculation
	Defective compressor	Replace
Fluctuating head & vapor pressures	Air or non-condensable in system	Recover refrigerant, evacuate & recharge
Gurgle or pulsing noise at expansion	Air or non-condensable in system	Recover refrigerant, evacuate & recharge

## START-UP CHECK LIST

### MANDATORY START-UP CHECK LIST AND RECORD

#### IMPORTANT!

This page is a mandatory checklist & record – the check to be executed and data to be recorded for future reference in case of failure.

A copy of this checklist data must be submitted to Carrier representative. Completion of this checklist is a must for any field claim, no field support will be provided for incomplete or blank checklists.

#### Preliminary Information

Outdoor Model Number		Outdoor Serial Number	
Indoor Model Number		Indoor Serial Number	
Startup Date		Technician Name	
Customer Name/Address		Project Name	
Additional Accessories			

Pre-Start-Up Checklist	Yes	No	NA
<b>Outdoor Unit</b>			
Is there any shipping damage?			
If the unit is damaged, please specify where:			
Will this damage prevent the unit start-up?			
Check power supply to see if it matches the unit data plate?			
Has the ground wire been properly connected?			
Are the circuit protection matched with the unit size and installed properly?			
Are the power wire gauge matched with the unit size and installed properly?			
<b>Piping</b>			
Are both refrigerant lines flushed / cleaned, connected to service valve sets and properly tightened?			
Are all the service valves open and back seated?			
Is the Stem Valves Installed and snug?			
Have all the refrigerant connections and piping joints checked for leaks and vacuum test conducted to 500 microns?			
<b>Indoor Fan Coil Unit Piping</b>			
Check accurate device size is matched and installed in fan coil unit? (If Applicable)			
Are the refrigerant connections properly connected and have been checked for leakages?			
Is condensate line connected?			
Is the condensate line free from obstacle and drains freely?			
<b>Controls</b>			
Are control power lines connected to their control power terminal block?			
Are terminal snug in the housing?			
Are control power lines and control cables routed separately (Not in the same conduit and not in same multi-conductor cable)?			
Are control wires connected to the same circuit as associated refrigerant lines?			
Check to make sure the subbase mounting to wall is secure. (Don't apply excessive force to mounting screw)			

Fan System			
Does fan rotate freely?			
Are air filters in place and clean?			
Indoor Power Supply			
Does the power supply match the fan coil unit data plate?			
Is ground wire connected?			
Start-Up Checklist	Yes	No	NA
Check Indoor Fan Operation Under Ceiling Fan Coil Units			
Select fan mode, then initiate test sequence. Does the fan motor start at low speed, then shift to medium then to high?			
Start System Operation at the Fan Coil Unit			
Select cooling mode and adjust set point, it must be below current room temperature then observe unit operation.			
Does compressor start (After Initial Time Delay) and Run?			
Does outdoor fan run properly?			
After at least 15 minutes of running time, record all the information below:			
Outdoor Unit		Fan Coil Unit	
Unit Amps(L1/L2/L3)		Indoor Entering Air DB (Dry Bulb) Temp	
Voltage (L1/L2/L3)		Indoor Leaving Air DB (Dry Bulb) Temp	
Vapor Line Pressure		Indoor Entering Air WB (Wet Bulb) Temp	
Vapor Line Temp		Indoor Leaving Air WB (Wet Bulb) Temp	
Liquid Line Temp		Technician Name, Signature and Date:	
Entering Outdoor Air Temp			
Leaving Outdoor Air Temp			

Manufacturer reserves the right to change, at any time, specifications and designs without notice and without obligations.